

# Getting Started Guide

P/N 0-230049-01



## MicroBar 9730 Decoder

Guide de démarrage

Leitfaden «Wie starte ich»

Guía de inicio

Guida introduttiva

Start Guide

入門ガイド

初次使用指南

 **ntermec**

A **UNOVA** Company

# Getting Started



ON

This guide contains the minimum set-up information for the most common host terminals. The full list of set-up commands can be found in the EasySet set-up software on the CD ROM (enclosed) or in the MicroBar 9730 Installation Manual (available on the CD ROM or to order). EasySet PC Windows software allows the set-up commands to be printed as set-up bar codes or to be downloaded using a special configuration cable. When installing and turning on the MicroBar 9730, ensure that the host system is turned off before connecting the cables. Follow these steps: 1. Turn system power off. 2. Connect devices (input and terminal). 3. Turn system power on. 4. Scan terminal type. 5. Select symbology. 6. Test.

## Démarrage

Ce guide contient le minimum d'informations nécessaires à la configuration de votre produit pour les terminaux hôtes les plus courants. Vous trouverez l'ensemble des commandes de configuration dans le logiciel EasySet fourni sur le cd-rom et dans le manuel d'installation MicroBar 9730 (également fourni sur le cd-rom ou document papier à commander). EasySet fonctionne sous Windows pour PC. Avec EasySet vous pouvez imprimer les commandes de configuration sous la forme de codes à barres ou les télécharger directement dans votre produit à travers un câble spécial de configuration. Quand vous installez votre produit, assurez-vous que le système hôte est éteint avant de faire les branchements. Suivez ces étapes : 1. Eteindre le système. 2. Brancher dispositifs de lecture et terminal. 3. Allumer le système. 4. Lire le type de terminal. 5. Choisir vos symbologies (types de codes à barres). 6. Tester.

## Was zunächst zu tun ist...

Dieser Leitfaden beinhaltet die wichtigsten Konfigurationsinformationen für die gebräuchlichsten Host Terminals. Die komplette Liste der Konfigurationsbefehle finden Sie in der EasySet-Konfigurationssoftware auf dem beigefügten CD ROM oder im MicroBar 9730 Installationshandbuch, das ebenfalls auf dem CD ROM abrufbar oder auf Bestellung erhältlich ist. Die für Windows PC konzipierte Software EasySet ermöglicht es, Konfigurationsbefehle in Form von Einstellungs-Barcodes auszudrucken oder sie mit Hilfe eines speziellen Konfigurationskabels herunterzuladen. Stellen Sie bei der Installation des MicroBar 9730 sicher, daß das Hostsystem ausgeschaltet ist, bevor Sie die Kabel anschließen. Gehen Sie folgendermaßen vor: 1. Das System abschalten. 2. Peripheriegeräte (Eingänge und Terminal) anschließen. 3. Das System einschalten. 4. Terminaltyp erkennen. 5. Die Barcodes auswählen. 6. Testen.

## Para començar...

Esta guía contiene la información mínima que permite configurar los terminales host más comunes. Una lista completa de comandos de configuración se encuentra en el software de configuración EasySet en CD ROM (incluido), o en el manual de instalación MicroBar 9730 (disponible en CD ROM o bajo pedido). El software Windows PC Easyset permite imprimir los comandos de configuración en formato código de barras, o telecargarlos utilizando un cable de configuración especial. Cuando instale el MicroBazr 9730, cerciórese de que el sistema host se encuentra apagado antes de conectar los cables; siga las etapas siguientes: 1. ponga el sistema fuera de servicio. 2. Enchufe los periféricos (entradas y terminal). 3. Ponga el sistema en funcionamiento. 4. Lea el tipo de terminal. 5. Seleccione el tipo de simbología. 6. Haga una prueba.

## Prima di iniziare...

Questa guida contiene le informazioni essenziali che consentono di configurare i più comuni terminali ospiti. L'elenco completo dei comandi di configurazione si trova all'interno del software EasySet su CD ROM (in dotazione) oppure nel Manuale d'Installazione del MicroBar 9730 (disponibile su CD ROM o su ordinazione). Il software EasySet per Windows PC consente di stampare i comandi di configurazione sotto forma di codici a barre di configurazione oppure di scaricarli utilizzando un apposito cavo di configurazione. Al momento dell'installazione del MicroBar 9730, prima di collegare i cavi, accertarsi che il sistema ospite non sia alimentato. Attenersi alla seguente procedura: 1. Spegnerne l'alimentazione del sistema. 2. Collegare le periferiche (input e terminale). 3. Alimentare il sistema. 4. Procedere ad una lettura del tipo di terminale. 5. Selezionare le simbologie che si intendono utilizzare. 6. Testare il sistema.

## Komma igång

Denna guide innehåller information för hur du installerar MicroBar 9730 för de vanligaste datorerna. En komplett förteckning uppsättningsparametrarna hittar du i EasySet programvaran på CD-ROM skivan eller i MicroBar 9730 Installations manual (tillgänglig på CD-ROM skivan eller via separat beställning). EasySet är en Windows™ baserad PC programvara som möjliggör antingen en utskrift av en streckkodsmeny med uppsättningsparametrarna så du lätt kan scanna in rätt konfigurering, du kan även ladda ner rätt konfigurering med hjälp av en speciell konfigureringskabel. När du installerar MicroBar 9730 skall din dator vara frånslagen. Du installerar på följande sätt. Steg 1- Stäng av strömmen. 2- Koppla upp anordningen. 3- Sätt på strömmen. 4- Scanna streckkoden för aktuell dator. 5- Välj rätt typ av symbologi (streckkod). 6- Testa.

# 1. Connect Input Device



**1** System power OFF

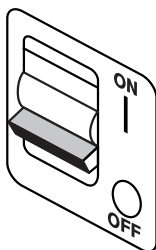

**2**

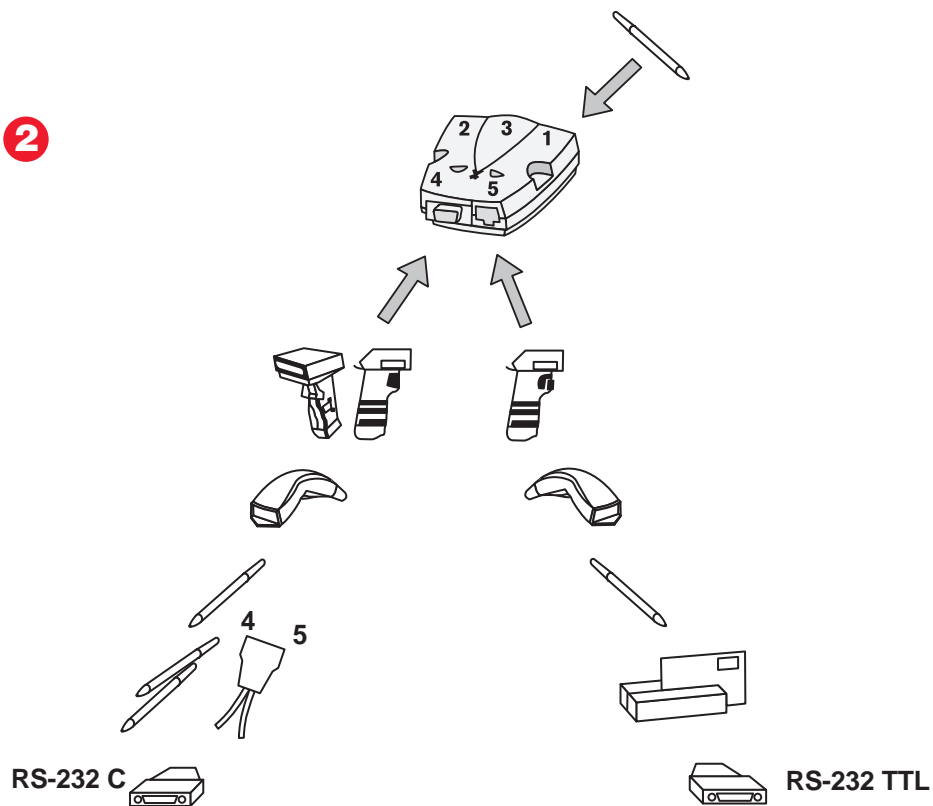

## 2. Connect to Terminal



OFF

### Keyboard Wedge, 2 cables

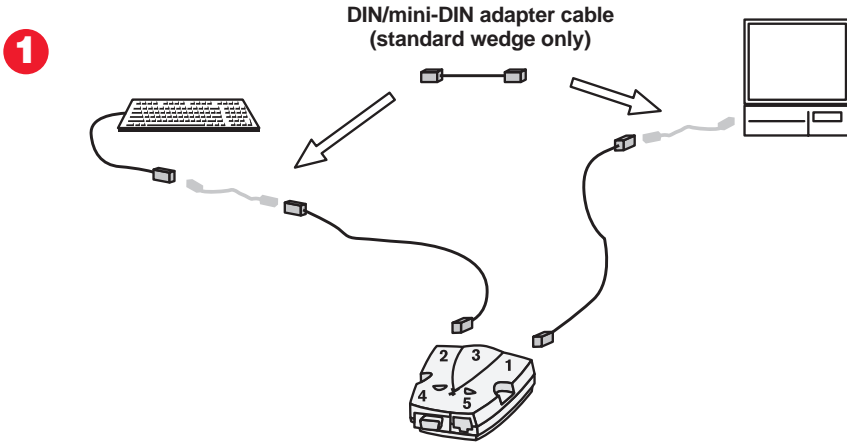

**2** System power ON



### 3 Scan terminal type (PCs and compatibles)



QWERTY English (200)



German (204)

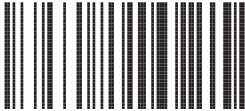

QWERTY Italian (206)

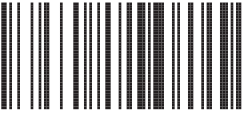

QWERTY Danish (208)



QWERTZ Swiss/French (2020)

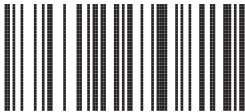

AZERTY French (201)

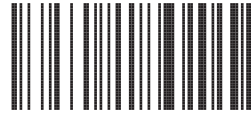

QWERTY Swedish/Finnish (205)

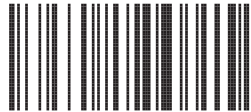

QWERTY Norwegian (207)

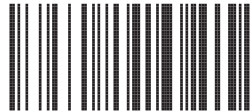

QWERTY Spanish (209)

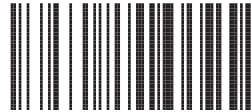

# Keyboard Wedge, Y cable

## 1 Connect cables

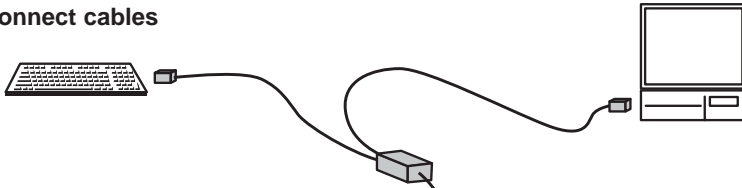

## 2 Plug in power supply

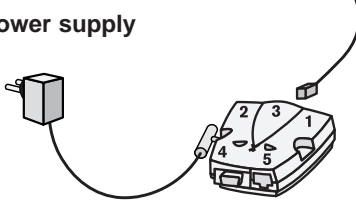

## 3 System power ON



## 4 Scan terminal type (DEC 220/320/420)



QWERTY PC type

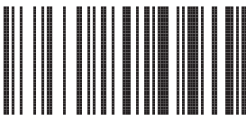

AZERTY PC type

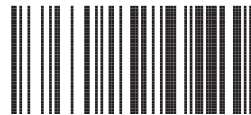

QWERTZ PC type

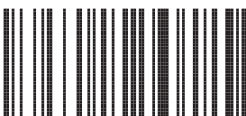

QWERTY PC type Swedish/Finnish

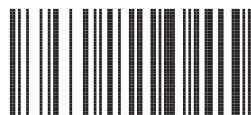

# Direct RS-232 Terminal

**1**

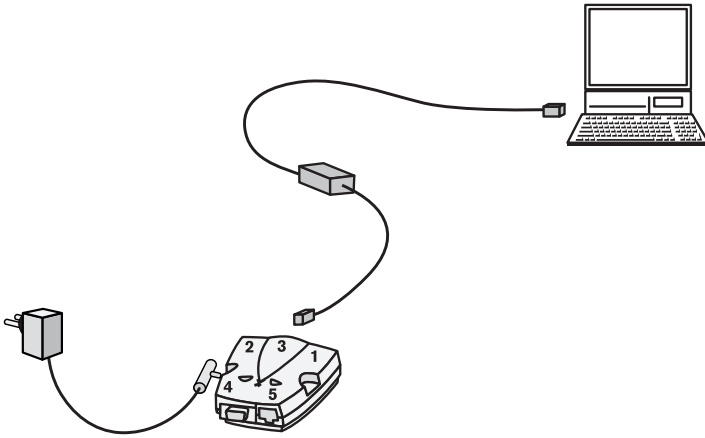

**2** System power ON



**3** Scan terminal type



RS232 C (9600, 7, E, 2)

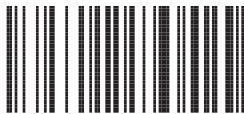

# Dual RS-232 Terminal

1

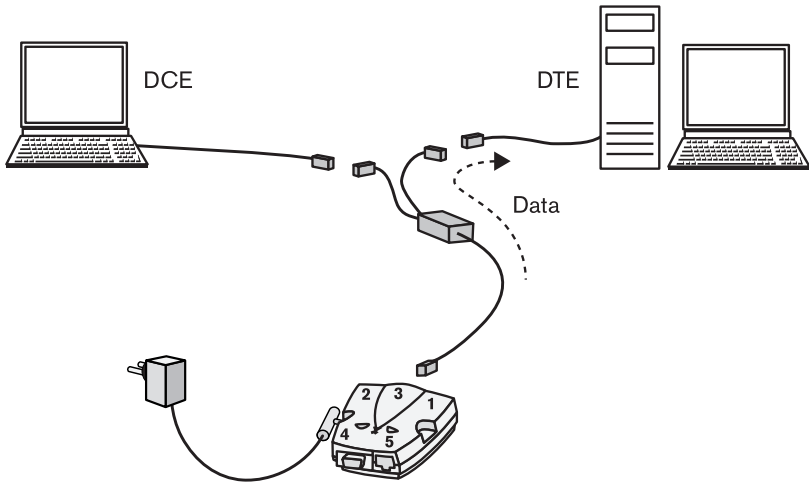

2 System power ON



3 Scan terminal type



RS232 C (9600, 7, E, 2)

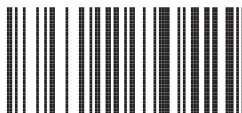

# 3. Select Symbology



Disable all Symbologies

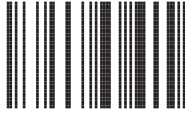

Activate Code

Test Code

Code 39 (\*)

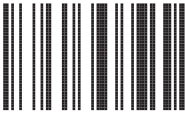

Code 39

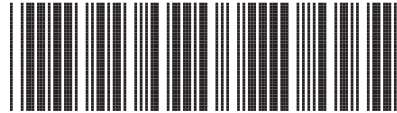

CODE-39

Code 128

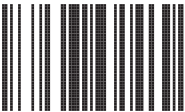

Code 128

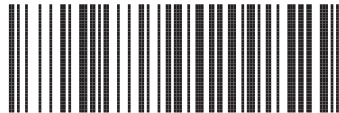

CODE-128

UPC/EAN

UPC-A, UPC-E, EAN-8, EAN-13 (\*)  
(UPC-A → EAN-13)



EAN-13



UPC/EAN

UPC-A, UPC-E, EAN-8, EAN-13  
(UPC-A → UPC-A)



UPC-A



# 4. Advanced Setup



## Postamble

data <...> (none)

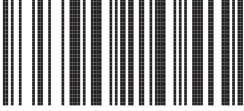

data <CR>

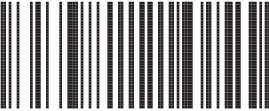

Enter

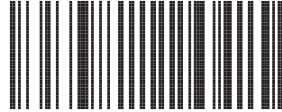

data <TAB>

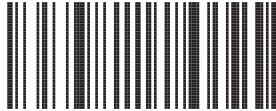

## Beeper volume



high (\*)

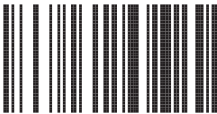

medium

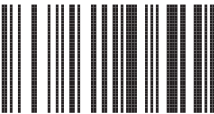

low

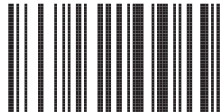

## Reset

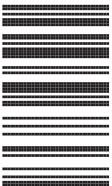

# Online Set-up



**1**

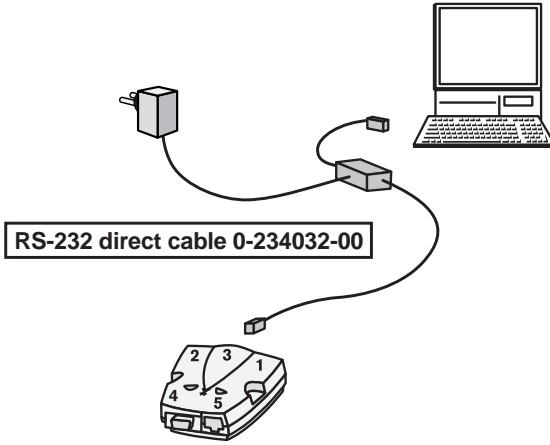

**2** System power ON



**3** Start EasySet

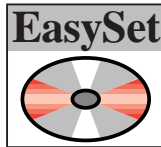

**4** Scan set-up code

RS-232 online set-up mode

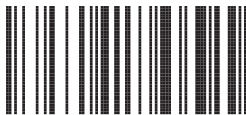

# Regulatory Statements

---

Intermec hereby declares that the following product has been tested and found compliant with the below listed standards as required by the EMC Directive 89/336/EEC as amended by 92/31/EEC and by the Low Voltage Directive 73/23/EEC as amended by 93/68/EEC:

EN55022 (1992)      EN50082-1 (1997)      EN60950 (1993)



**USA:** This device complies with Part 15 of the FCC Rules. Operation is subject to the following two conditions: (1) this device may not cause harmful interference, and (2) this device must accept any interference received, including interference that may cause undesired operation.

This equipment has been tested and found to comply with the limits for a Class B digital device, pursuant to part 15 of the FCC Rules. These limits are designed to provide reasonable protection against harmful interference in a residential installation. This equipment generates, uses and can radiate radio frequency energy and, if not installed and used in accordance with the instructions, may cause harmful interference to radio communications. However, there is no guarantee that interference will not occur in a particular installation. If this equipment does cause harmful interference to radio or television reception, which can be determined by turning the equipment off and on, the user is encouraged to try to correct the interference by one or more of the following measures:

- Reorient or relocate the receiving antenna.
- Increase the separation between the equipment and receiver.
- Connect the equipment into an outlet on a circuit different from that to which the receiver is connected.
- Consult the dealer or an experienced radio/TV technician for help.

**CANADA:** This Class B digital apparatus meets all requirements of the Canadian Interference-Causing Equipment Regulations. Cet appareil numérique de la classe B respecte toutes les exigences du Règlement sur le matériel brouilleur du Canada.

**AUSTRALIA-NEW ZEALAND:** This equipment has been tested and found to conform to the Australian EMC framework concerning Class B digital devices, prescribed by the Australian and New-Zealander standard AS/NZS 3548.



The information contained in this manual is for informational purposes only and is subject to change without notice. No part of this leaflet may be copied or reproduced in any manner without the prior written permission of Intermec Technologies Corporation.

© Intermec Technologies Corporation All Rights Reserved

The word Intermec, the Intermec logo, MicroBar and EasySet are either trademarks or registered trademarks of Intermec.

Throughout this manual, trademarked names may be used. Rather than put a trademark (™ or ®) symbol in every occurrence of a trademarked name, we state that we are using the names only in an editorial fashion, and to the benefit of the trademark owner, with no intention of infringement.

---

**NorthAmerica/Asia Pacific/Latin America** • 6001 36th Avenue West • PO Box 4280 • Everett WA 98203-9280 • tel +1 425 348 2600 • fax +1 425 348 2833 • U.S. service and technical support, tel 1.800.755.5505 • Canadian service and technical support, tel: 1.800.688.7043

---

**Europe/ Middle East / Africa** • Sovereign House • Vastern Roadtel Reading RG1 8BT • England • Tiel +44 118 987 9420 • fax +44 118 987 9416

---

**Internet** • <http://www.intermec.com>

---

**E-mail** • [info@intermec.com](mailto:info@intermec.com)

© 8/98 Intermec Technologies Corporation. All rights reserved. 0:230049-01